

Material	Heavy gauge steel Hardened pins and bushes
Finish	Zinc Plated
Supplied with	10x70 mm spindles
Max holding force	545 daN
Weight	1.0 Kgs
Stroke	-
Clamping Pressure	170 daN

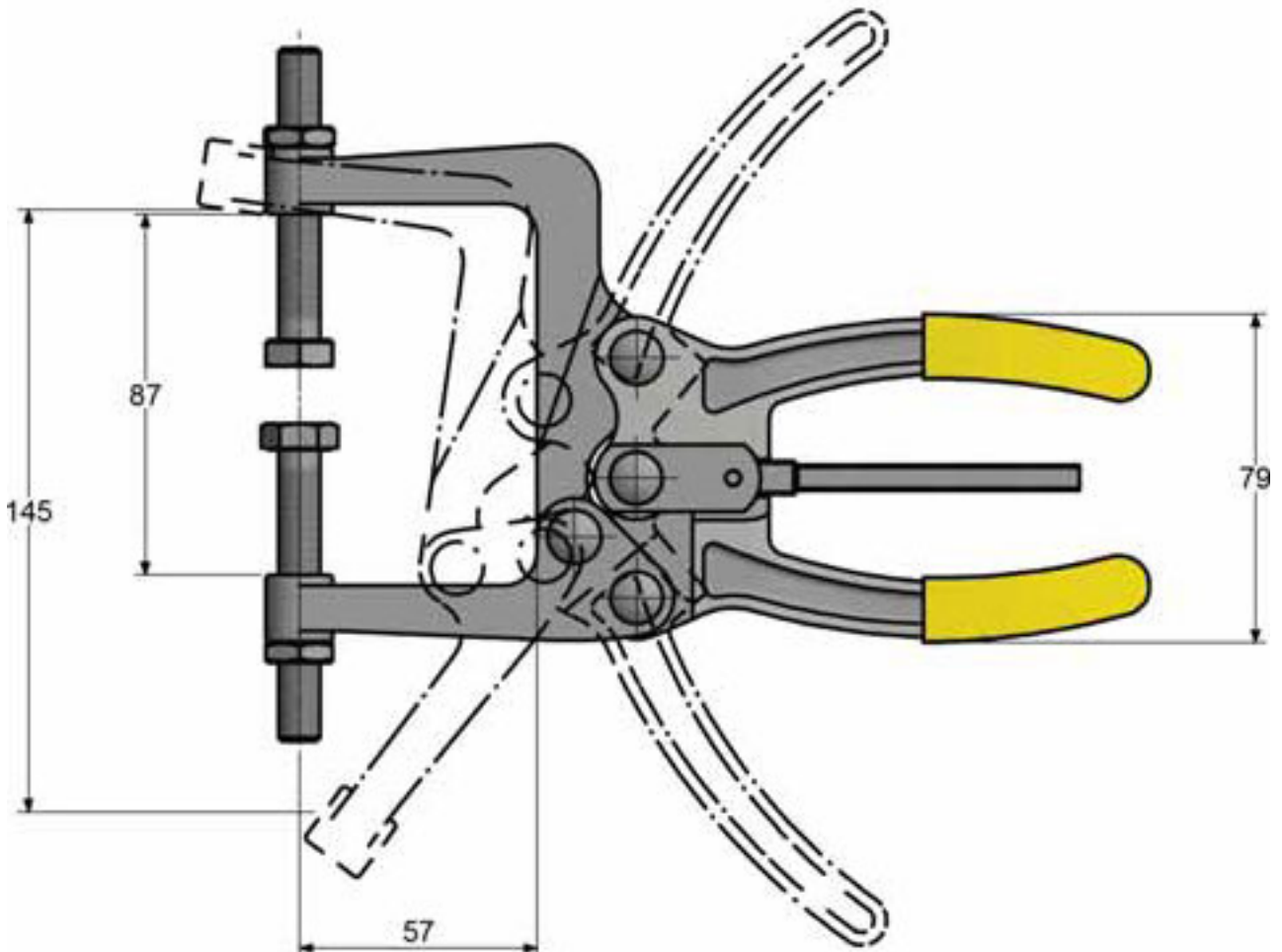
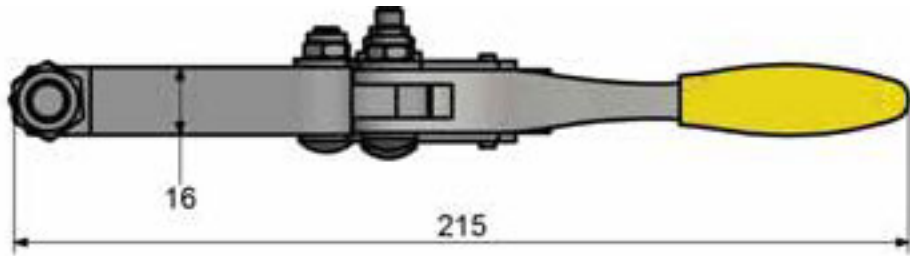

PLIER ACTION